

LOTUS

LOTUS50, LOTUS100, LOTUS150 y LOTUS200

**MOTOBOMBAS MULTITAPAS HORIZONTALES
EN ACERO INOXIDABLE**

FICHA TÉCNICA

SERIE LOTUS

LOTUS50, LOTUS100, LOTUS150 y LOTUS200

ESPECIFICACIONES

Las motobombas serie LOTUS están diseñadas con un cuerpo hidráulico construido completamente en acero inoxidable. Ofreciendo una solución confiable y eficiente en las aplicaciones donde se requiere que el agua no tenga contacto con materiales sujetos a oxidación.

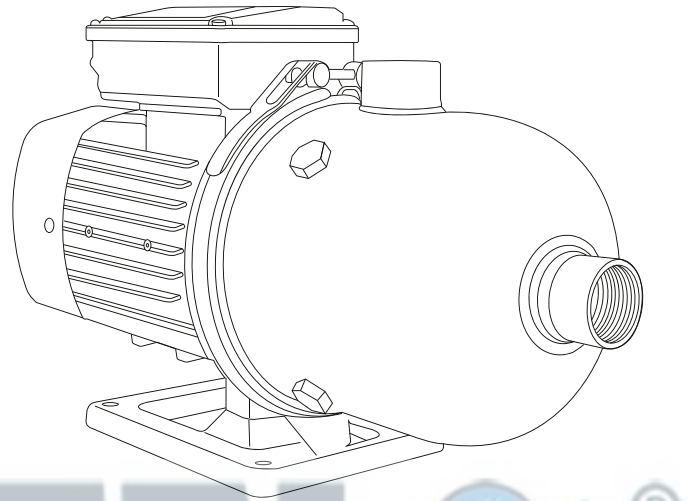

APLICACIONES

- Suministro de agua a viviendas
- Sistemas de Ósmosis Inversa
- Sistemas hidroneumáticos
- Sistemas de presión constante
- Aplicaciones en la industria
- Sistemas de riego

CARACTERÍSTICAS DE CONSTRUCCIÓN

- Cuerpo, impulsores, succión y descarga en acero inoxidable 304
- Eje en acero inoxidable 316
- Sello mecánico en carburo de silicio/carbón

MOTOR

- Carcasa en aluminio
- Asíncrono, dos polos
- Cerrado, enfriado por aire
- Protección IP55
- Aislamiento clase F (para alta temperatura)
- Protección térmica incorporada en los modelos monofásicos
- Servicio continuo

CARACTERÍSTICAS DE OPERACIÓN

- Temperatura máxima de líquido a bombear: 70°C
- Máxima temperatura ambiente: 50°C
- Autoaspirante hasta: 2 m

DESCRIPCIÓN DEL CÓDIGO

LOTUS 100 -4 /1 230

Serie

Caudal nominal
en litros por minuto

Número de etapas

Número de fases

Voltaje del motor



CURVAS DE OPERACIÓN



TABLA DE ESPECIFICACIONES

CÓDIGO	HP	KW	FASES X VOLTS	AMP.	SUCCIÓN X DESCARGA	DMS*	PRESIÓN AL CIERRE (m/psi)	CARGA EN METROS (psi)							
								25 (35.5)	35 (49.7)	45 (63.9)	55 (78.1)	65 (92.3)	75 (106.5)		
								GASTO (litros por minuto)							
LOTUS50-4/1127	0.75	0.55	1 x 127	9	1 " x 1"	1.25"	51/72	66	47	22					
LOTUS50-4/1230			1 x 230	5.2											
LOTUS50-4/3234			3 x 230/460	3 / 1.5											
LOTUS50-5/1127	1	0.75	1 x 127	10.8			1 " x 1"	1.25"	64/91		61	45	26		
LOTUS50-5/1230			1 x 230	6											
LOTUS50-6/1127			1.2	0.9											
LOTUS50-6/1230	1 x 230	6.3													

*DMS= Diámetro mínimo sugerido para tubería de succión.

CURVAS DE OPERACIÓN

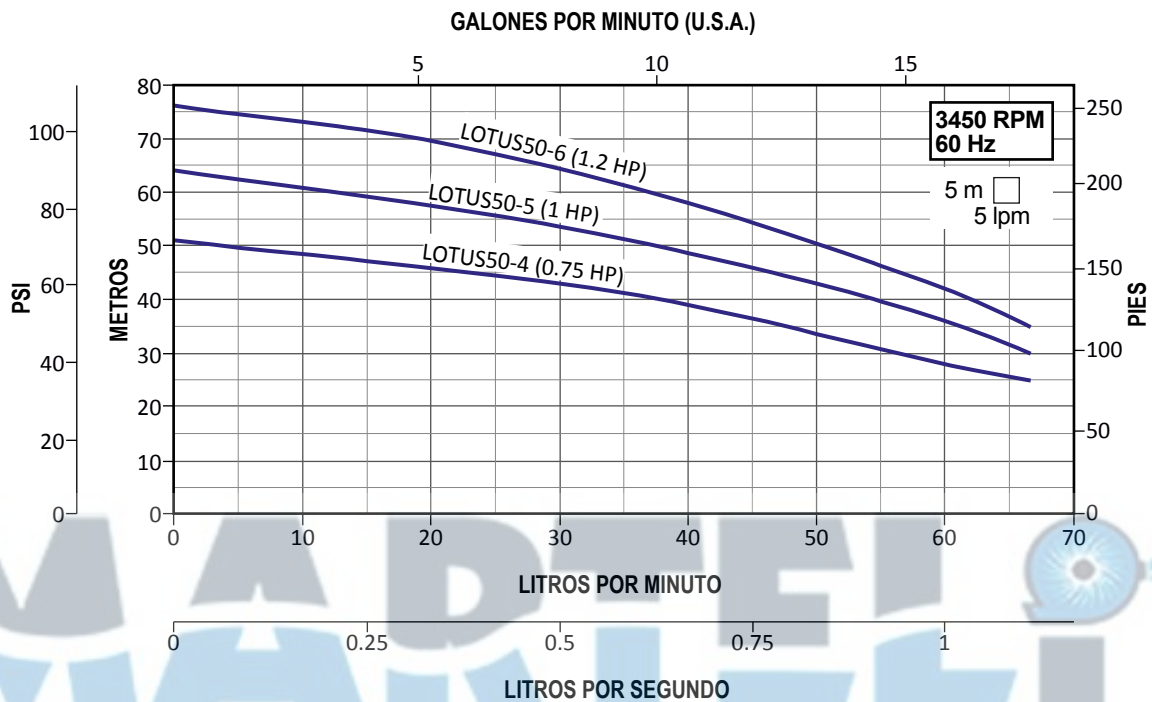

TABLA DE ESPECIFICACIONES

CÓDIGO	HP	KW	FASES X VOLTS	AMP.	SUCCIÓN X DESCARGA	DMS*	PRESIÓN AL CIERRE (m/psi)	CARGA EN METROS (psi)			
								15 (21.3)	25 (35.5)	35 (49.7)	45 (63.9)
								GASTO (litros por minuto)			
LOTUS100-3/1127	1	0.75	1 x 127	11.5	1.25" x 1"	1.5"	42/60	133	102	64	
LOTUS100-3/1230			1 x 230	6.2							
LOTUS100-3/3234			3 x 230/460	4 / 2							
LOTUS100-4/1127	1.2	0.9	1 x 127	12.2	1.25" x 1"	1.5"	54/76	120	96	52	
LOTUS100-4/1230			1 x 230	7							
LOTUS100-4/3234			3 x 230/460	4.4 / 2.2							

*DMS= Diámetro mínimo sugerido para tubería de succión.

CURVAS DE OPERACIÓN

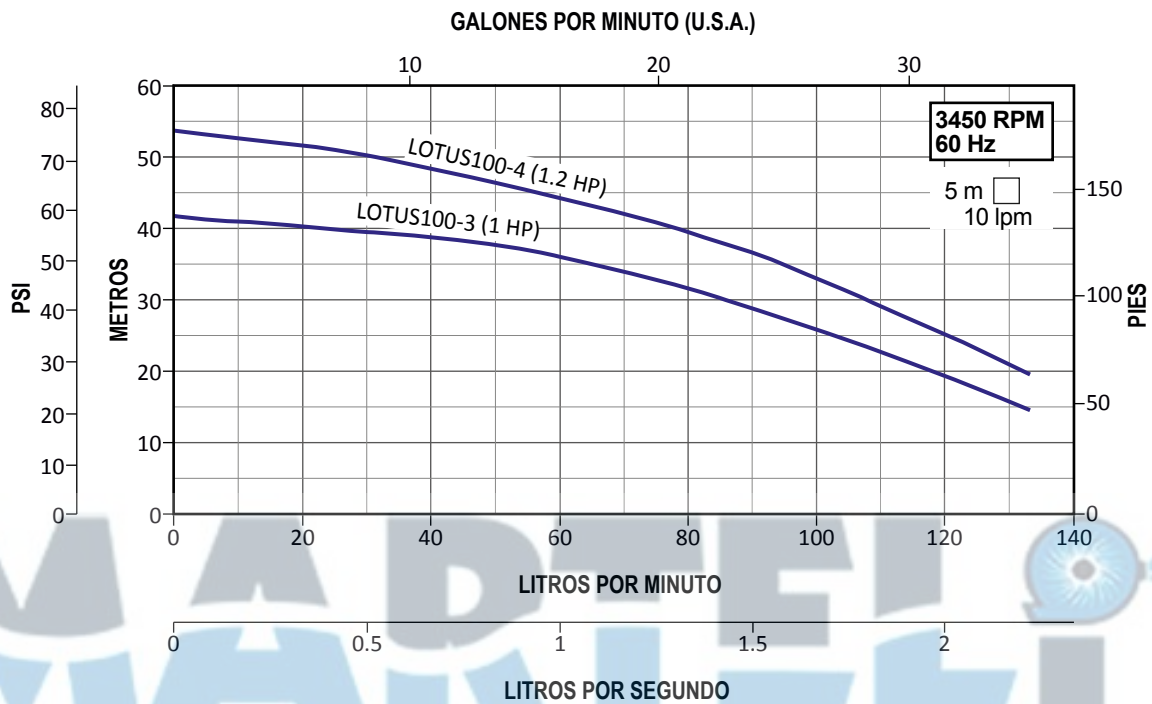

TABLA DE ESPECIFICACIONES

CÓDIGO	HP	KW	FASES X VOLTS	AMP.	SUCCIÓN X DESCARGA	DMS*	PRESIÓN AL CIERRE (m/psi)	CARGA EN METROS (psi)					
								15 (21.3)	25 (35.5)	35 (49.7)	45 (63.9)	55 (78.1)	65 (92.3)
								GASTO (litros por minuto)					
LOTUS150-3/1230	2	1.5	1 x 230	14	1.5" x 1.5"	2"	45/64	300	230	150			
LOTUS150-3/3234				8.5 / 4.5									
LOTUS150-4/3234	3	2.2	3 x 230/460	10.4 / 5.2			60/85		270	225	170	70	
LOTUS150-5/3234	4	3		11 / 5.5			71/101		300	255	220	180	80

*DMS= Diámetro mínimo sugerido para tubería de succión.

CURVAS DE OPERACIÓN

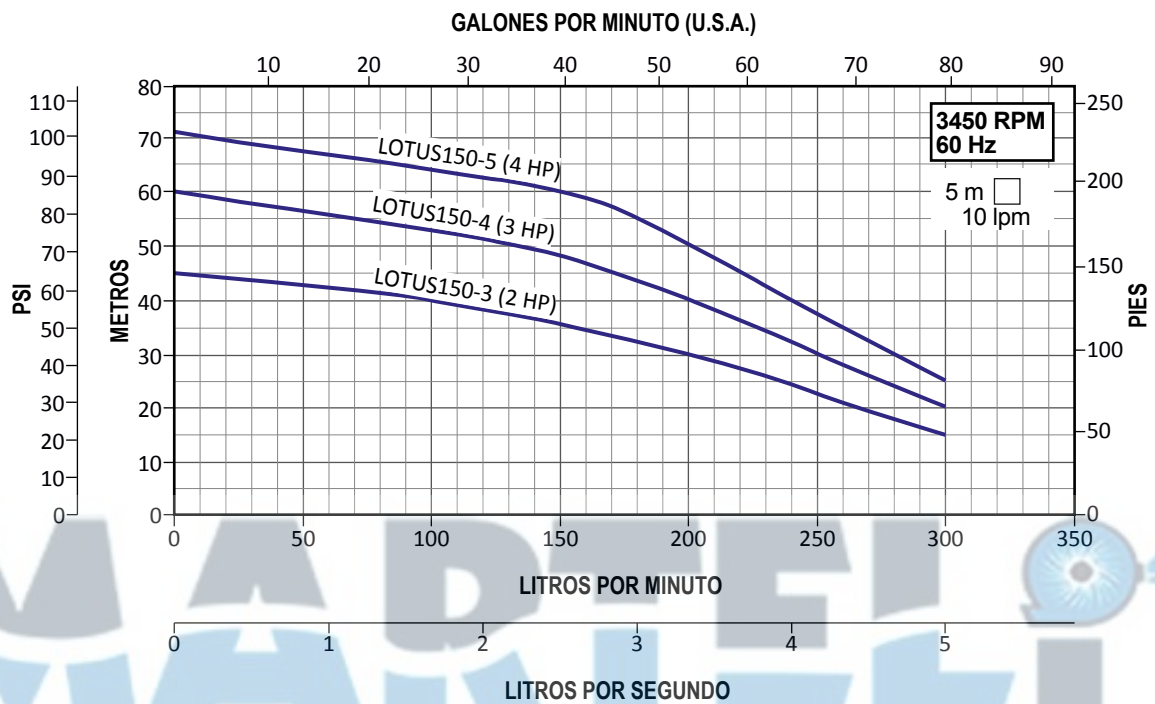

TABLA DE ESPECIFICACIONES

CÓDIGO	HP	KW	FASES X VOLTS	AMP.	SUCCIÓN X DESCARGA	DMS*	PRESIÓN AL CIERRE (m/psi)	CARGA EN METROS (psi)				
								25 (35.5)	35 (49.7)	45 (63.9)	55 (78.1)	65 (92.3)
								GASTO (litros por minuto)				
LOTUS200-2-1/1230	2	1.5	1 x 230	14	1.5" x 1.5"	2"	45/64	266	180			
LOTUS200-2-1/3234				8.8 / 4.4								
LOTUS200-2/3234	3	2.2	3 x 230/460	10.4 / 5.2			55/78.1	215	130			
LOTUS200-3/3234	4	3		11 / 5.5			58/82	295	210	60		

*DMS= Diámetro mínimo sugerido para tubería de succión.

DIMENSIONES Y PESOS

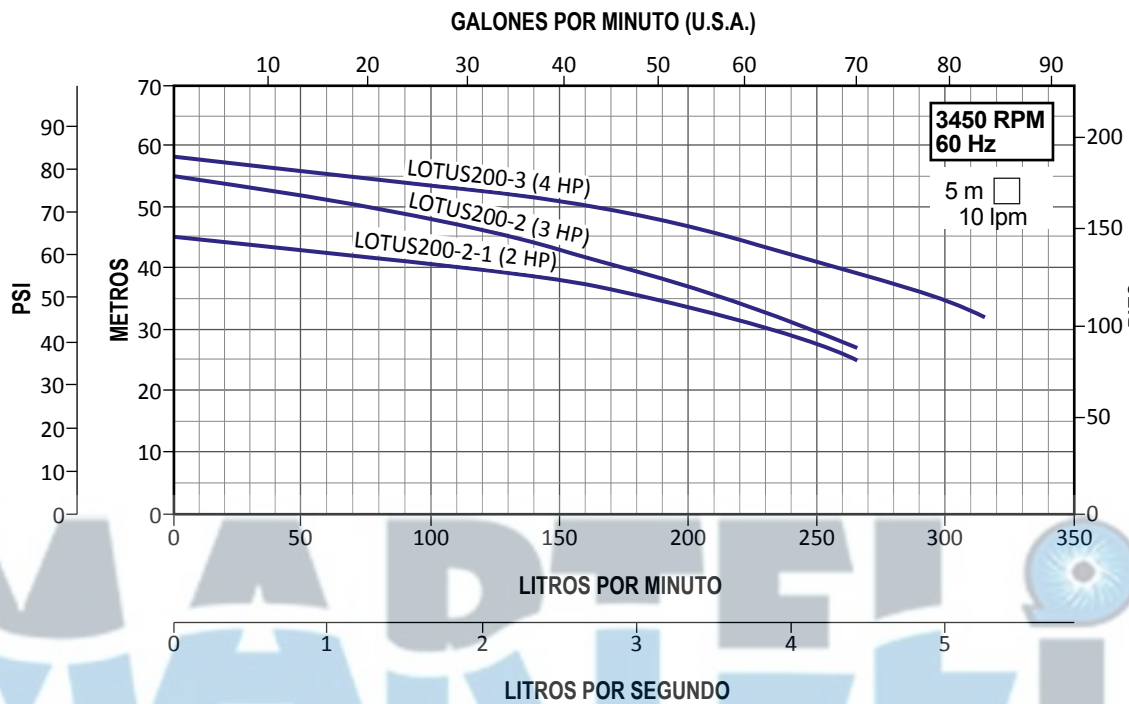
CÓDIGO	DIMENSIONES											PESO (kg)
	mm									pulgadas		
	L1	L2	L3	L4	L5	L6	L7	L8	H	D1	D2	
LOTUS50-4/1127	405	160	138	130	110	208	165	108	232	1	1	10.5
LOTUS50-4/1230									210			
LOTUS50-4/3234									232			
LOTUS50-5/1127									11			
LOTUS50-5/1230												
LOTUS50-6/1127												
LOTUS50-6/1230												

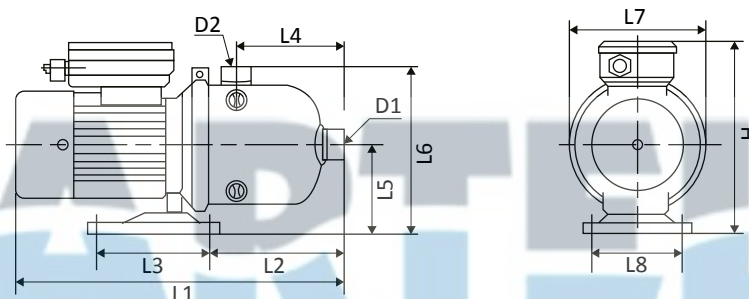

CÓDIGO	DIMENSIONES											PESO (kg)
	mm									pulgadas		
	L1	L2	L3	L4	L5	L6	L7	L8	H	D1	D2	
LOTUS100-3/1127	405	160	138	130	110	208	165	108	232	1.25	1	13
LOTUS100-3/1230									210			
LOTUS100-3/3234									232			
LOTUS100-4/1127									14			
LOTUS100-4/1230												
LOTUS100-4/3234												
	210											

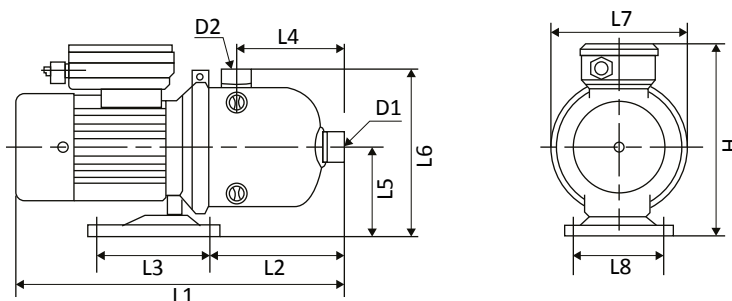

DIMENSIONES Y PESOS

CÓDIGO	DIMENSIONES										PESO (kg)	
	mm									pulgadas		
	L1	L2	L3	L4	L5	L6	L7	L8	H	D1		D2
LOTUS150-3/1230	500	180	139	160	138	120	242	205	239	1.5	1.5	24
LOTUS150-3/3234	455								232			
LOTUS150-4/3234	518								239			
LOTUS150-5/3234	583	546	205									29

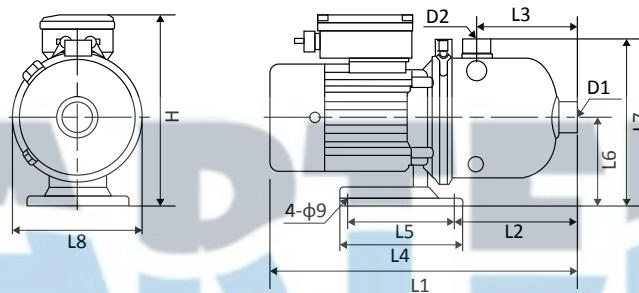

CÓDIGO	DIMENSIONES										PESO (kg)	
	mm									pulgadas		
	L1	L2	L3	L4	L5	L6	L7	H	D1	D2		
LOTUS200-2-1/1230	500	180	138	139	120	242	205	239	1.5	1.5	24	
LOTUS200-2-1/3234	458							232				
LOTUS200-2/3234	518							239				
LOTUS200-3/3234	518										27	

